

Article number: 390204400732716

Description: Worm Gear with Torque Limiter
VF 44-L1-V-7-P71B5

Measures

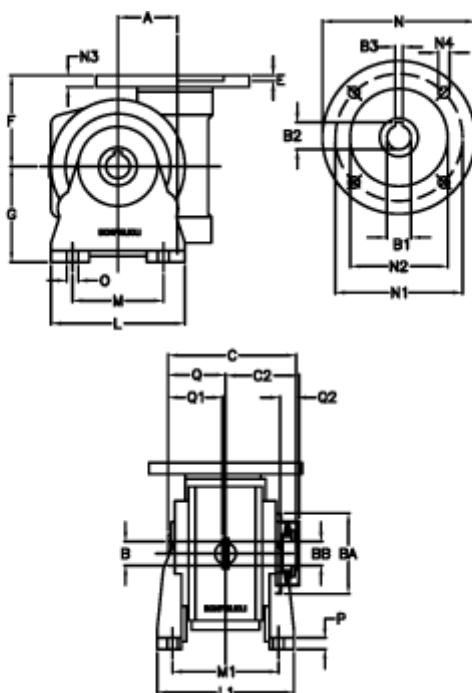

a	= 44.60	C2	= 48	M1	= 81.0	Q	= 32.0
B	= 18	Description	= VF 44V-xx-71B5	N	= 160	Q1	= 32
B1 E7	= 14	E	= 2.0	N1	= 130	Q2	= 12
B2	= 16.3	F	= 65	N2	= 110		
B3 H9	= 5	g	= 72	N3	= 10.5		
BA	= 40	L	= 90	N4	= 9,5		
BB H7	= 11	L1	= 98.0	O	= 8.5		
C	= 79	m	= 52	P	= 10		